

Arbi Bathroom

# Materia

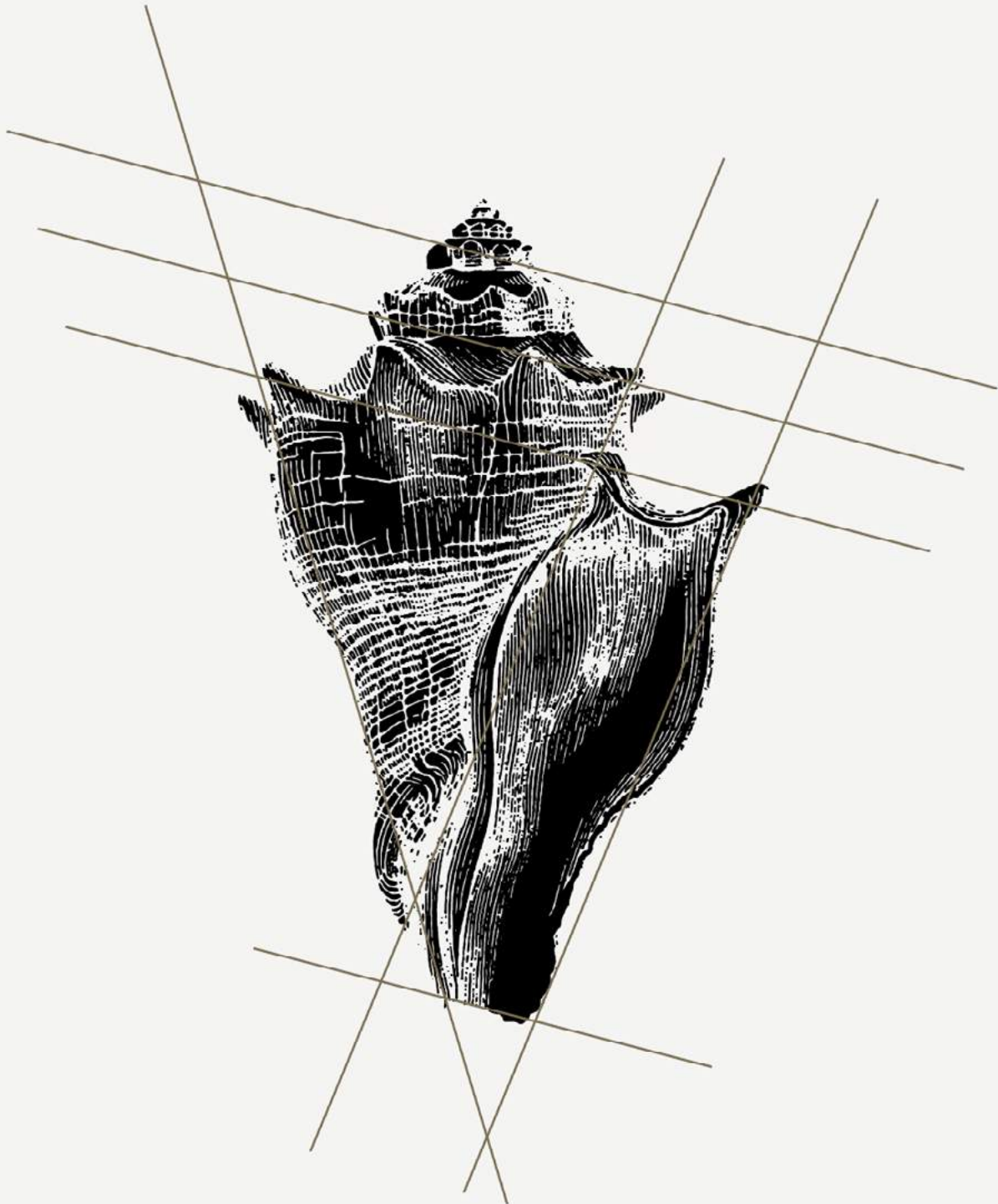

**Arbi**

**Bathroom**

**collection**

**MATERIA**

**index**

**p 04—07**  
comp. 01

**p 08—15**  
comp. 05

**p 16—21**  
comp. 02

**p 22—27**  
comp. 03

**p 28—33**  
comp. 04

**p 34—41**  
comp. 06

**p 42—47**  
comp. 07

**p 48—53**  
comp. 08

L  
D  
Y  
T  
I  
M  
E  
I  
K  
I



Semplici, razionali, pulite sono le linee di questa composizione dalle dimensioni contenute. Il cassettoni H 51 cm in Rovere Antico Crema fa risaltare tutta la matericità ed il calore del legno, enfatizzato anche dalla struttura del mobile laccata Bianco velvet e dal lavabo in Fenix Bianco Kos: un incontro tra natura e tecnologia che esalta entrambi i materiali.

This compact composition stands out for its simple, structured, and clean-cut lines. The Antico Crema oak large drawer (H 51 cm) emphasises the wood's texture and warmth, which is also highlighted by the structure of the velvet Bianco lacquered unit and the Fenix Bianco Kos washbasin. The perfect combination of nature and technology to bring the best out of the two materials.

Les lignes de cette composition aux dimensions contenues sont simples, rationnelles, nettes. Le grand tiroir H 51 cm en Chêne Antico Crema met en relief toute la matière et la chaleur du bois, également emphatisé par la structure du meuble laquée Bianco velvet et par le lavabo en Fenix Bianco Kos: une rencontre entre nature et technologie qui exalte les deux matériaux.

Schlicht, rational und klar sind die Linien dieser Kombination mit kompakten Abmessungen. Die Kommode H 51 cm in Eiche Antico Crema setzt die plastische Optik und die Wärme von Holz perfekt in Szene, die auch durch das lackierte Gestell des Möbels in Bianco Velvet und das Waschbecken in Fenix Bianco Kos unterstrichen werden: ein Zusammentreffen von Natur und Technologie, das beide Materialien hervorhebt.

Простые, рациональные и чистые линии отличают эту композицию небольших размеров. Ящик H 51 см в отделке Дуб Antico Crema подчеркивает текстуру и тепло дерева, акцентируемого также каркасом шкафа в отделке лакированный Bianco velvet и раковиной из Fenix Bianco Kos: встреча природы и технологии, которая придает красоту обоим материалам.

## MATERIA VIP composizione 01

**dimensioni** L 120.6 × P 50.5 cm

**finiture** 8A2 ROVERE ANTICO CREMA  
/ 905V0 LACCATO BIANCO VELVET

**lavabo** Plaza in Fenix Bianco Kos Sp.1.2 x L 120.6  
x P 50.5 cm

**specchiera** Pulsar L 120 × H 73.4 cm

905V0  
Bianco velvet

8A2 Rovere  
Antico Crema







Il Rosso Casale è protagonista assoluto della composizione: la base, con vano a giorno, laccata Rosso Casale velvet si sposa perfettamente con il piano con lavabo Kuki integrato in Fenix nella stessa tinta. La specchiera Boheme con profilo in alluminio Inox e led superiore e inferiore di serie definisce lo spazio e dona luce e freschezza all'ambiente.

Rosso Casale reigns supreme in this composition: the velvet lacquered Rosso Casale base, with open shelving wall-cabinet, fits perfectly with the same colour Kuki integrated top in Fenix. The Boheme wall mirror, with stainless steel aluminium frame, fitted with upper and lower led as standard, defines the space, conferring light and freshness upon the interior.

Le Rosso Casale règne en maître absolu dans cette composition : la base laquée Rosso Casale velouté à étagère ouverte se marie parfaitement avec le plan de toilette intégré Kuki en Fenix de la même couleur. Le miroir Boheme, avec un profil d'aluminium Inox et un éclairage led de série en haut et en bas, délimite l'espace tout en apportant lumière et fraîcheur à la pièce.

Rosso Casale ist der absolute Star der Komposition: der Unterschrank mit offenem Fach, in Rosso Casale Velvet lackiert, verbindet sich perfekt mit der Waschtischplatte mit dem Becken Kuki, das in Fenix in derselben Farbe integriert ist. Der Spiegel Boheme mit Profil aus rostfestem Aluminium und leds oben und unten definiert den Raum und schenkt dem Ambiente Licht und Frische.

Покрытие Rosso Casale является центральным акцентом композиции: тумба с открытой полкой в лакированной обработке Rosso Casale Velvet идеально сочетается со столешницей Fenix с интегрированной мойкой Kuki в том же цвете. Зеркало Boheme из этой серии с профилем из нержавеющей стали со светодиодной подсветкой сверху и снизу определяет характер пространства, добавляет в интерьер света и свежести.

**dimensioni** L 120.6 × P 50.5 cm

—  
**finiture** WF LACCATO ROSSO CASALE VELVET

**lavabo** Kuki in Fenix Rosso Casale velvet Sp.1.2 x L 120.6 x P 50.5 cm

**specchiera** Boheme in alluminio Inox L 120 × H 61.2 cm

## MATERIA VIP composizione 05

WF Rosso  
Casale velvet







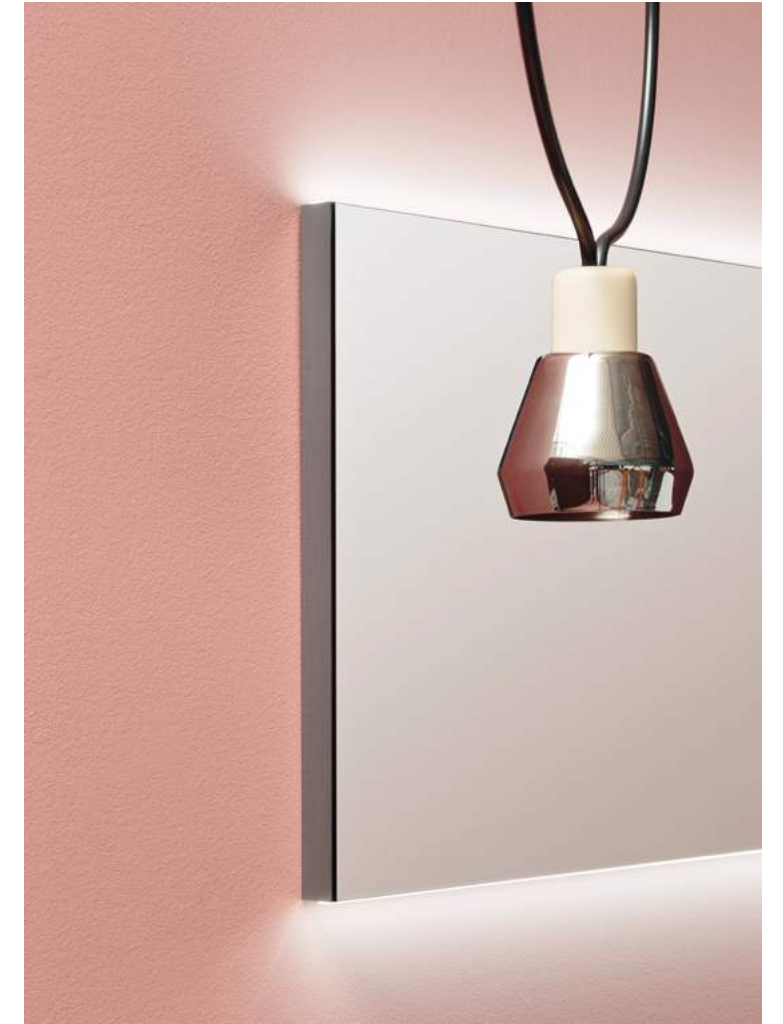



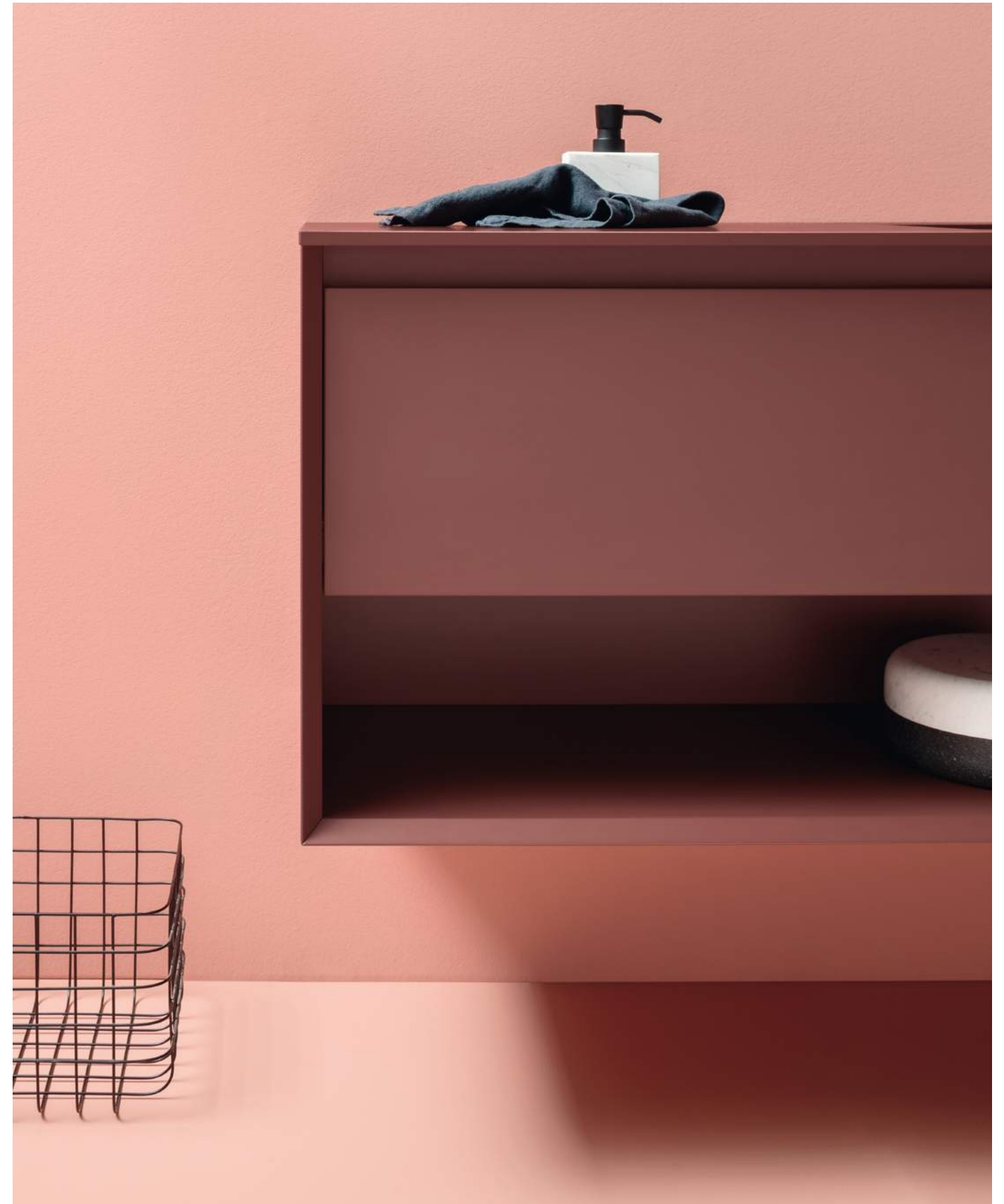

La specchiera Light Tonda, con il suo diametro importante, ed il faretto Ufo danno luce a questa composizione decisamente minimalista, formata da un cassettone con frontale in Rovere Antico Inchiostro e struttura in laccato Grigio Londra velvet. Il lavabo King in tekno rispetta sia la pulizia delle linee dell'insieme che la scelta di materiali moderni e altamente tecnologici.

The large Light Tonda mirror and the Ufo spotlight add light to this minimalist composition, which consists of a large drawer with an Antico Inchiostro oak front panel and a Grigio Londra velvet lacquered structure. The Tekno King washbasin blends with the clean-cut lines of the composition and the choice of modern, high-tech materials.

Le miroir Light Tonda, avec son important diamètre, et le spot Ufo donnent de la lumière à cette composition très minimaliste, formée d'un grand tiroir avec façade en Chêne Antico Inchiostro et structure en laqué Grigio Londra velvet. Le lavabo King en tekno respecte aussi bien la netteté des lignes de l'ensemble que le choix des matériaux modernes et hautement technologiques.

Der Spiegel Light Tonda mit seinem bedeutenden Durchmesser und die Leuchte Ufo bringen Licht in diese entschieden minimalistische Kombination, die aus einer Kommode mit Front aus Eiche Antico Inchiostro und einem lackierten Gestell in Grigio Londra Velvet besteht. Das Waschbecken King aus Tekno respektiert sowohl die Klarheit der Linien der gesamten Komposition als auch die Wahl moderner und hoch technologischer Materialien.

Зеркало Light Tonda с внушительным диаметром и светильник Ufo придают свет этой минималистичной композиции, которая состоит из ящика с фасадом в отделке Дуб Antico Inchiostro и каркаса в отделке лакированный Grigio Londra velvet. Раковина King из текно соблюдает чистоту линий композиции и выбор современных и высокотехнологичных материалов.

**dimensioni** L 120.6 × P 50.5 cm  
(L 140 cm con sporgenza specchio)

**finiture** 8AA ROVERE ANTICO INCHIOSTRO  
/ WJ LACCATO GRIGIO LONDRA VELVET

**lavabo** King in tekno

**piano** in Fenix Grigio Londra Sp. 1.2 × L 120.6  
× P 50.5 cm

**specchiera** Light Tonda Ø 100 cm

**faretto** Ufo a sospensione

## MATERIA VIP composizione 02

WJ Grigio  
Londra velvet

8AA Rovere  
Antico Inchiostro

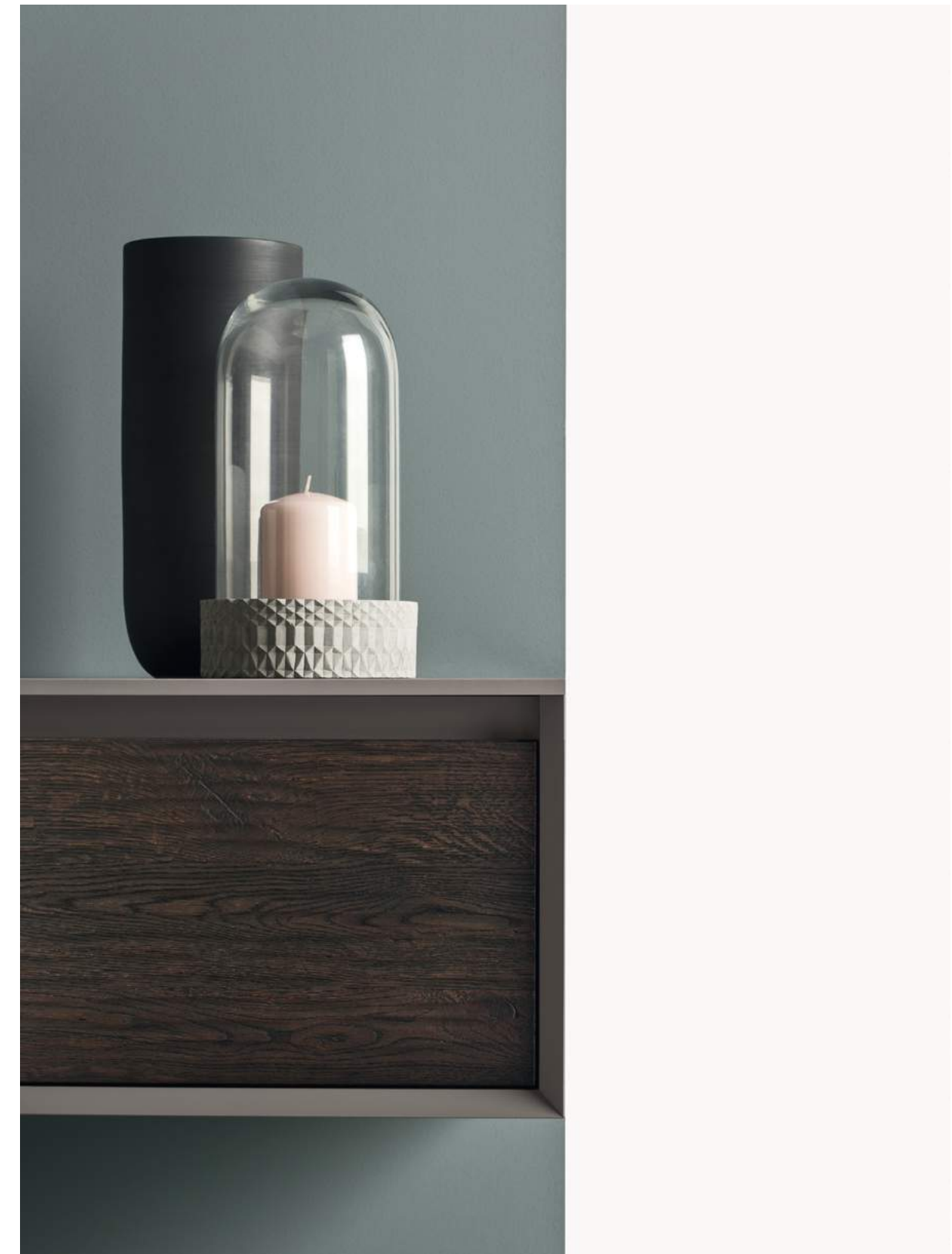







Il bianco come sfondo ideale per queste due composizioni contenute ma complete e funzionali. Il cassetto con frontale laccato Bianco lucido è racchiuso dalla struttura in laccato Verde Comodoro velvet e la finitura lucida è richiamata dal lavabo in ceramica Seed 45. La specchiera Light con il faretto led On rendono la composizione la soluzione ideale per arredare un bagno piccolo ma con stile.

White is the perfect backdrop for these two essential yet complete and functional compositions. The drawer with a glossy Bianco lacquered front panel is enclosed in a Verde Comodoro velvet lacquered structure. The glossy finish is echoed on the Seed 45 ceramic washbasin. The Light mirror with the 'On' LED spotlight make this composition the ideal solution for furnishing a small bathroom with style.

Le bianco comme fond idéal pour ces deux compositions contenues mais complètes et fonctionnelles. Le tiroir avec façade laquée Bianco brillant est renfermé dans la structure en laqué Verde Comodoro velvet et la finition brillante est rappelée par le lavabo en céramique Seed 45. Le miroir Light avec le spot led On fait de la composition la solution idéale pour meubler une salle de bain petite mais avec style.

Weiß ist der ideale Hintergrund für diese beiden Kombinationen, die kompakt und zugleich komplett und funktional sind. Die Schublade mit lackierter Front in Bianco glänzend ist in dem lackierten Gestell in Verde Comodoro Velvet enthalten, und das glänzende Finish wird vom Waschbecken aus Keramik Seed 45 aufgegriffen. Der Spiegel Light mit der LED-Leuchte On machen die Kombination zur idealen Lösung zum Einrichten eines kleinen aber stilvollen Badezimmers.

Белый фон идеально подходит для этих двух композиций, сдержанных, но в то же время полных и функциональных. Ящик с фасадом в отделке лакированный глянцевый Bianco, является частью каркаса в отделке лакированный Verde Comodoro velvet, а глянцевая отделка повторяется раковиной из керамики Seed 45. Зеркало Light со светильником led On делают композицию идеальным решением для оформления маленькой, но стильной ванной комнаты.

**dimensioni** L 85.6 × P 50.5 cm

**finiture** 901L0 LACCATO BIANCO LUCIDO / WL LACCATO VERDE COMODORO VELVET  
**lavabo** Seed 45 in ceramica  
**piano** in Fenix Verde Comodoro Sp. 1.2 x L 85.6 × P 50.5 cm  
**specchiera** Light L 36.8 × H 95 cm  
**faretto** On led

## MATERIA VIP composizione 03

WL Verde  
Comodoro velvet

901L0  
Bianco lucido

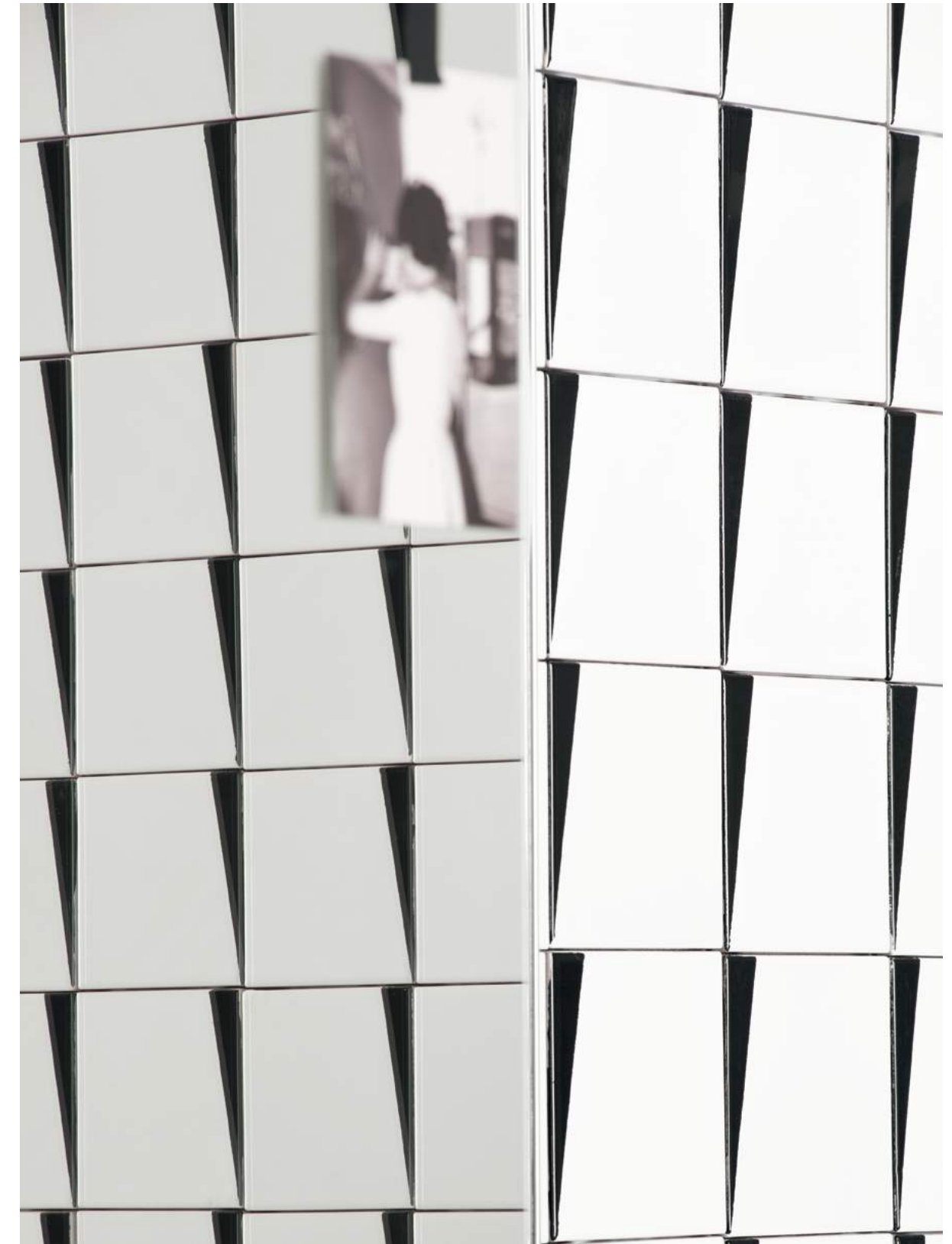



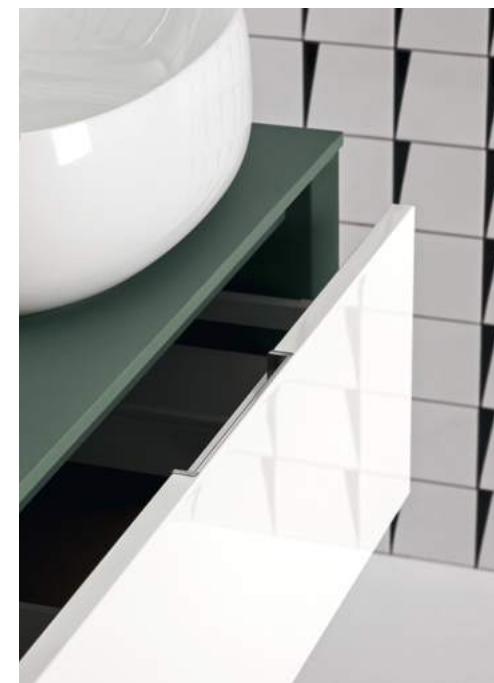
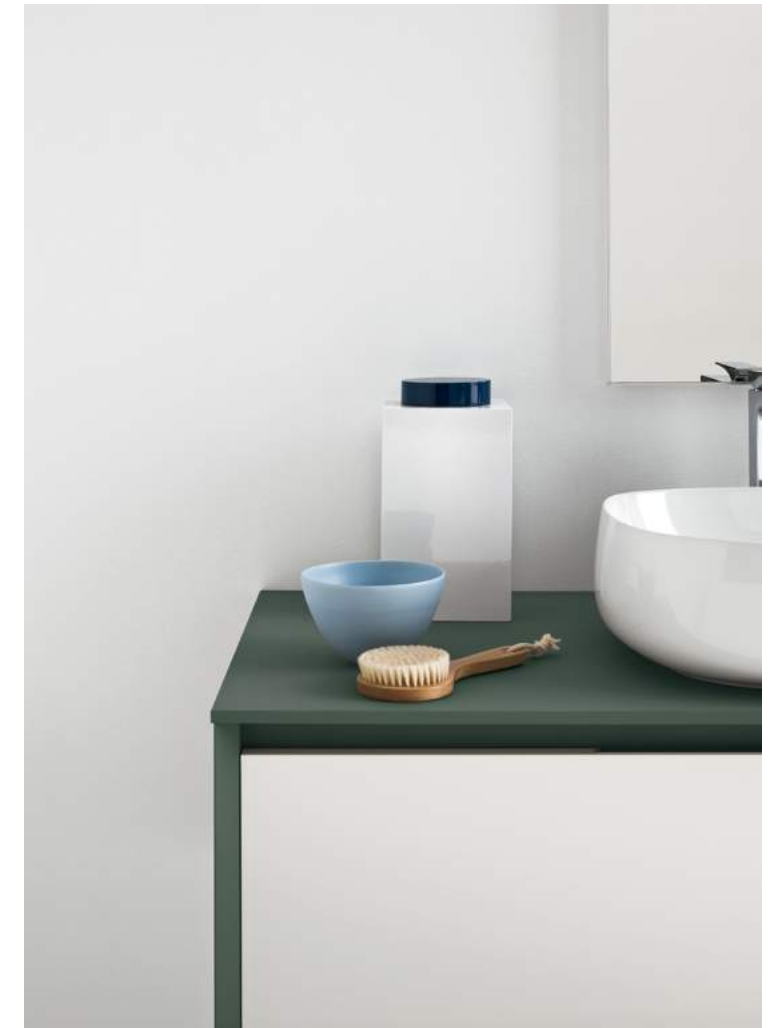



Il rigore della struttura tagliata a 45° laccata Grigio Efeso velvet, che incornicia il frontale in Rovere Antico Masai, ricrea le atmosfere di case dal design ricercato e minimale. La doppia vasca, il doppio cassettone e il capiente vano a giorno rendono la composizione funzionale seppur compatta. La specchiera Tao con led perimetrale definisce le geometrie dello spazio sopra al mobile.

The rigour of the 45 degree Grigio Efeso velvet lacquered structure, which frames the Antico Masai oak front panel, creates a sophisticated yet minimal atmosphere. The twin washbasin, the dual large drawer, and the spacious open-fronted compartment make this compact composition extremely functional. The Tao mirror with perimeter LED lights defines the space above the unit.

La rigueur de la structure découpée à 45° en laqué Grigio Efeso velvet, qui encadre la façade en Chêne Antico Masai, recrée les atmosphères de maisons au design recherché et minimal. Le double vasque, la double grand tiroir et le grand élément ouvert rendent la composition fonctionnelle bien que compacte. Le miroir Tao avec led périmétral définit les géométries de l'espace au-dessus du meuble.

Die Strenge des Gestells mit 45° Kante lackierten in Grigio Efeso velvet, das die Front aus Eiche Antico Masai umrahmt, ahmt die Atmosphäre von Wohnungen mit raffiniertem und minimalem Design nach. Das doppelte Becken, die doppelte Kommode und das geräumige offene Fach machen die Kombination funktional und doch kompakt. Der Spiegel Tao mit umlaufender LED-Leuchte definiert die Geometrien des Bereichs oberhalb des Möbels.

Строгость срезанного под углом 45° каркаса из лакированной Grigio Efeso velvet, обрамляющего фасад в отделке Дуб Antico Masai, воссоздает атмосферу домов с изысканным и минималистичным дизайном. Двойная чаша, двойной ящик и вместительная открытая ниша придают компактной композиции функциональность. Зеркало Tao с периметральным светодиодом определяет геометрию пространства над шкафом.

**dimensioni** L 140.6 × P 50.5 cm

**finiture** 8A9 ROVERE ANTICO MASAI  
/ WN LACCATO GRIGIO EFESO VELVET

**lavabo** Kuki doppia vasca in Fenix Grigio Efeso  
Sp. 1.2 x L 140.6 x P 50.5 cm + scivolo

**specchiere** Tao FM L 68.5 x H 61.2 cm (x 2) e L 140 x H 30 cm

## MATERIA VIP composizione 04

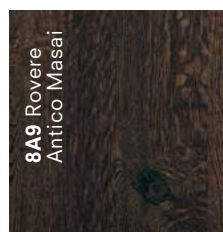
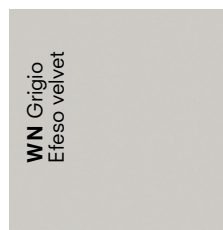









Due materiali pregiati si incontrano: il Noce Antico Biondo, materico e disegnato, viene abbinato al Fenix Bianco Kos, emblema del bianco puro, per creare una composizione discreta e raffinata. La specchiera Light Tonda con diametro 100 cm e faretto Off led completa lo spazio addolcendo le linee rigorose dell'ambiente.

The textured and detailed Antico Biondo walnut wood blends with Fenix Bianco Kos, the symbol of pure white par excellence, to create a discreet yet sophisticated composition. The Light Tonda mirror (diameter: 100 cm) with 'Off' LED spotlight completes the composition and softens the structured lines of the space.

Deux matériaux précieux se rencontrent : le Noyer Vieilli Biondo, matériqué et dessiné, est associé au Fenix Bianco Kos, emblème du bianco pur, pour créer une composition discrète et raffinée. Le miroir Light Tonda avec diamètre de 100 cm et spot Off led complète l'espace en adoucissant les lignes rigoureuses de l'espace ambiant.

Zwei hochwertige Materialien treffen aufeinander: Nussbaum Antico Biondo, plastisch und gemustert, und Fenix Bianco Kos, der Inbegriff von reinem Weiß, wobei eine dezente und raffinierte Kombination entsteht. Der Spiegel Light Tonda mit Durchmesser 100 cm und LED-Leuchte Off vollenden den Raum und nehmen seinen rigorosen Linien die Strenge.

Встреча двух ценных материалов: текстурный и вычерченный Орех Antico Biondo сочетается с Fenix Bianco Kos, эмблемой чистого белого, для создания сдержанной и изысканной композиции. Зеркало Light Tonda с диаметром 100 см и светильник Off led дополняют пространство, смягчая строгие линии помещения.

**dimensioni** L 140.6 × P 50.5 cm  
(L 155 cm con sporgenza specchio)

**finiture** 7A2 NOCE ANTICO BIONDO  
/ 905V0 LACCATO BIANCO VELVET  
**lavabo** Kuki in Fenix Bianco Kos Sp. 1.2 x L 140.6  
× P 50.5 cm + scivolo  
**specchiera** Light Tonda Ø 100 cm  
**faretto** Off led

## MATERIA VIP composizione 06

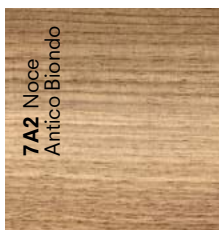







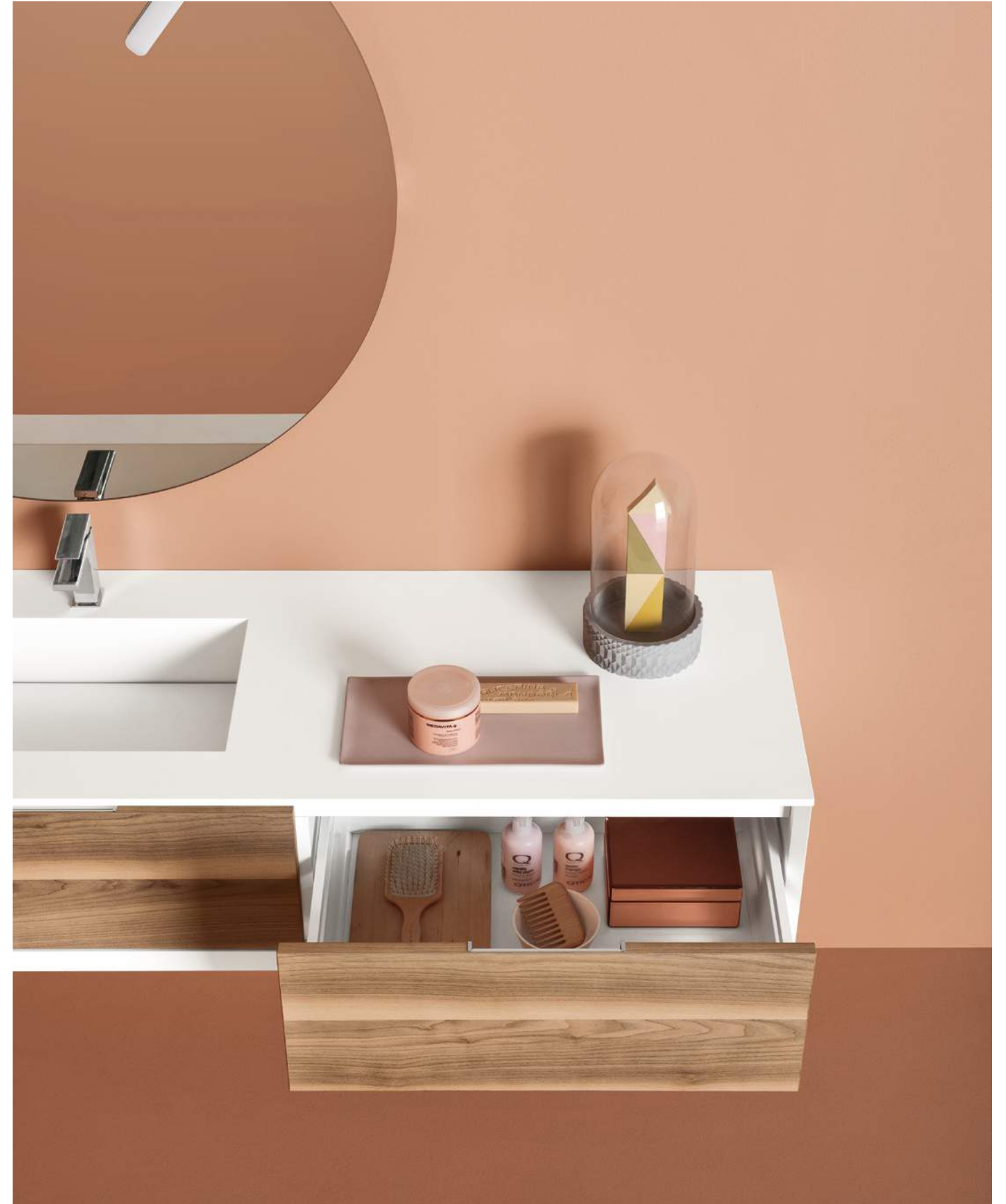

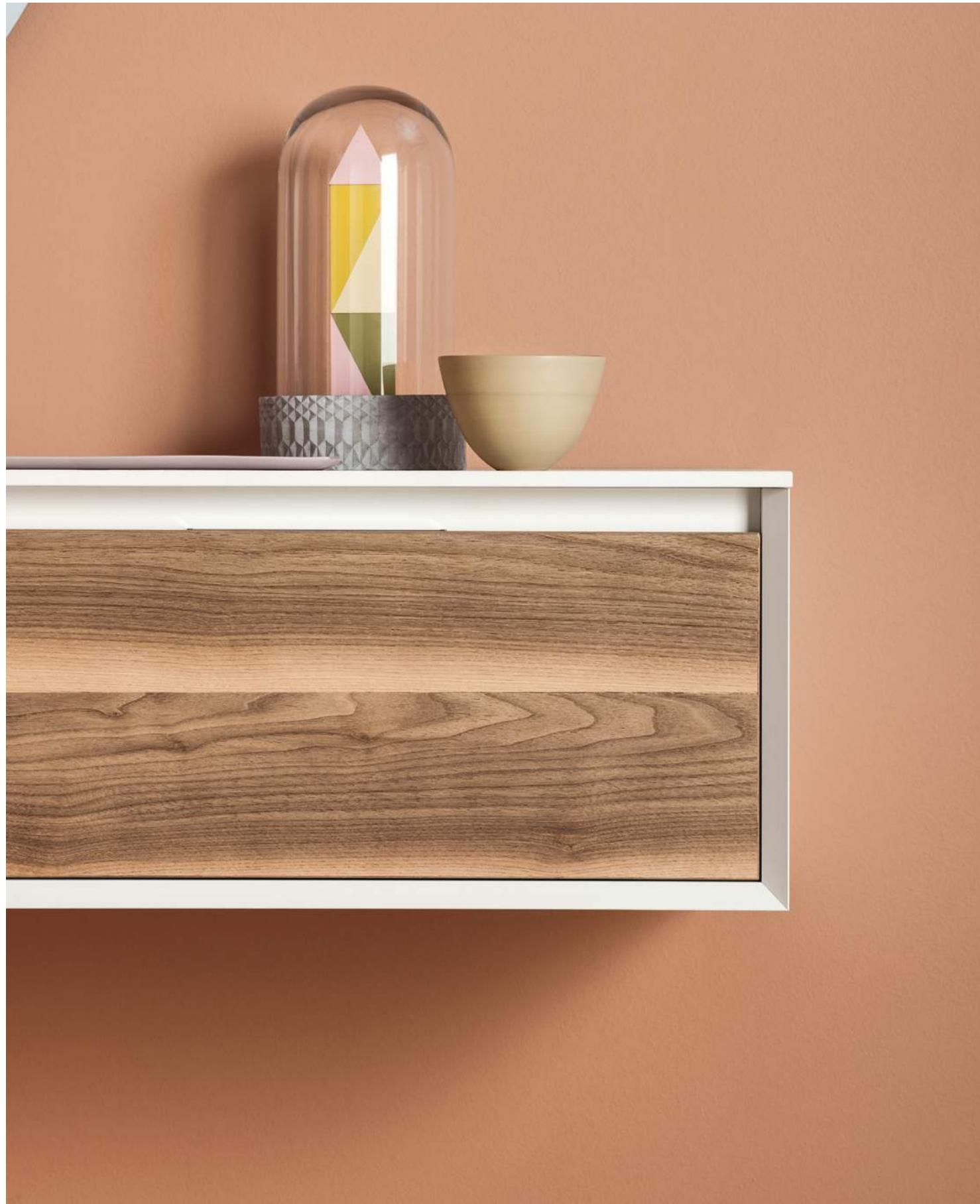



Il tono scuro della struttura laccata Grigio Bromo viene smorzato dal calore della vena del Rovere Antico Essenza. La base con cassettoni e vano a giorno valorizza il profilo a 45° della struttura. La specchiera Bishop in Rovere Essenza riprende la finitura del cassettoni dando ulteriore funzionalità all'insieme grazie al led perimetrale integrato.

The dark shade of the Grigio Bromo lacquered structure is muted by the warmth of the Antico Essenza oak grain. The base unit with a large drawer and open-fronted compartment emphasises the 45-degree profile of the structure. The Essenza oak Bishop mirror picks up on the finish of the large drawer and provides an additional functional touch, thanks to the built-in perimeter LED lights.

Le ton foncé de la structure laquée Grigio Bromo est atténué par la chaleur de la veine du Chêne Vieilli Essenza. L'élément bas avec grand tiroir et élément ouvert met en valeur le profil à 45° de la structure. Le miroir Bishop en Chêne Essenza reprend la finition du grand tiroir en donnant encore plus de fonctionnalité à l'ensemble grâce au led périmétral intégré.

Der dunkle Ton des Gestells lackierter Grigio Bromo wird von der Wärme der Maserung der Eiche Antico Essenza abgemildert. Der Unterschrank mit Kommode und offenem Fach unterstreicht die 45° Kante des Gestells. Der Spiegel Bishop aus Eiche Essenza greift die Oberfläche der Kommode auf und verleiht der gesamten Kombination dank der integrierten umlaufenden LED zusätzliche Funktionalität.

Темный тон каркаса лакированной Grigio Bromo приглушается теплыми прожилками Дуба Antico Essenza. Тумба с ящиком и открытой нишей подчеркивает красоту профиля каркаса под углом 45°. Зеркало Bishop в отделке Дуб Essenza повторяет отделку ящика, придавая дополнительную функциональность композиции благодаря встроенному периметральному светодиоду.

**dimensioni** L 120.6 × P 50.5 cm

**finiture** 8A8 ROVERE ANTICO ESSENZA / WO LACCATO GRIGIO BROMO VELVET

**lavabo** Kuki in Fenix Grigio Bromo sp.1.2 x L 120.6 × P 50.5 cm + scivolo

**specchiera** Bishop con profilo in Rovere Essenza L 120 × H 61.2 cm

## MATERIA VIP composizione 07

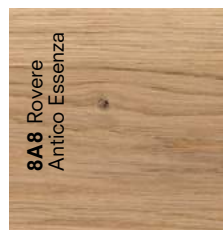



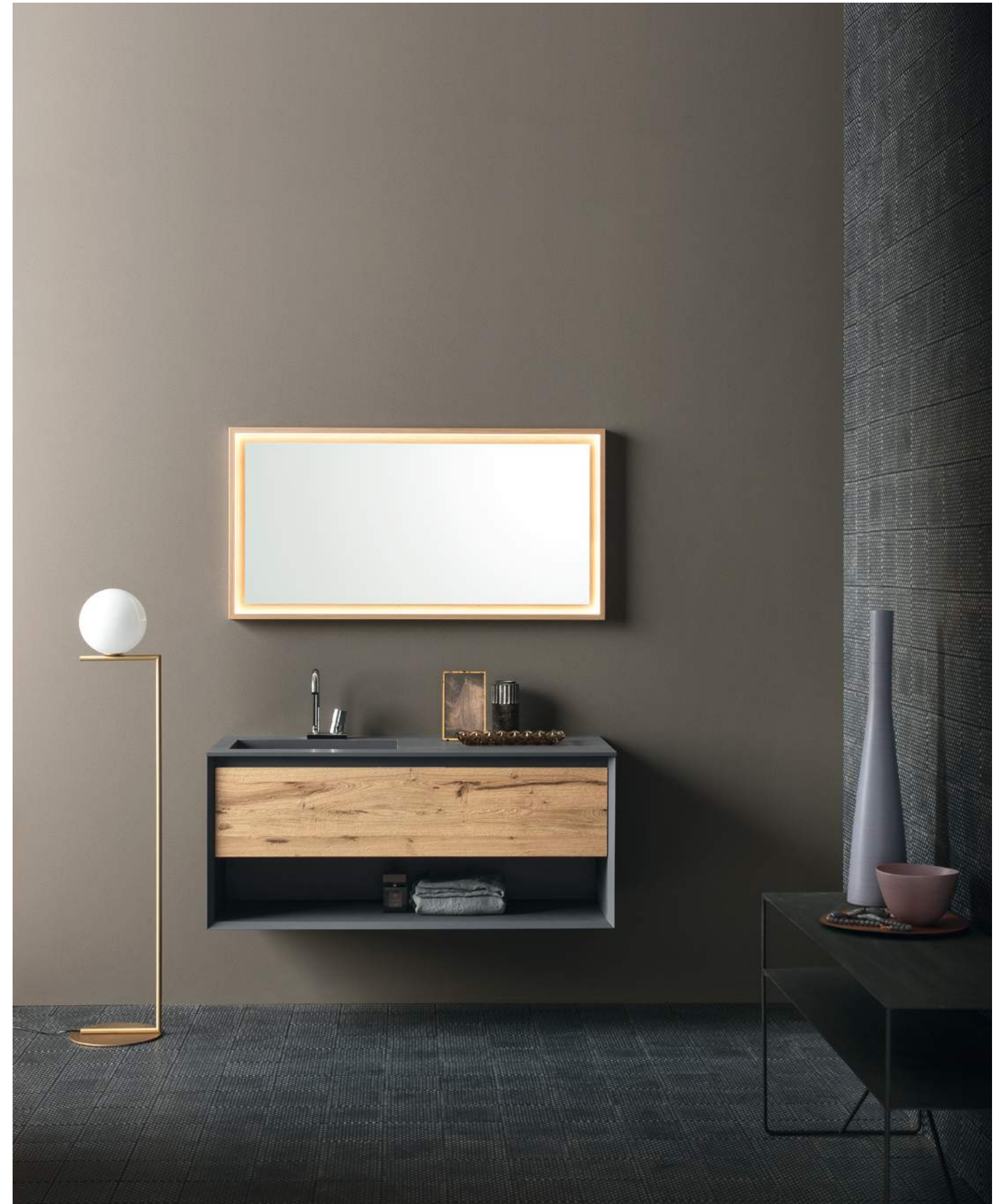







Rigore e prospettive decise caratterizzano queste composizioni gemelle in Noce Antico Scuro e laccato Bianco velvet. Il lavabo proposto è il Kuki, con vasca da 50 cm, che sfrutta in modo ottimale le dimensioni della base. La specchiera Light sottolinea le proporzioni e la verticalità dello spazio, accentuata dal faretto led Plano fissato sullo specchio.

This pair of twin Antico Scuro walnut and Bianco velvet lacquered compositions stand out for their bold and rigorous lines. The 50 cm Kuki washbasin fully exploits the dimensions of the base unit. The Light mirror and the Plano LED spotlight fastened to it emphasise the proportions and vertical lines of the composition.

La rigueur et les perspectives nettes caractérisent ces compositions jumelles en Noyer Antico Scuro et laqué Bianco velvet. Le lavabo proposé est Kuki, avec vasque de 50 cm, qui exploite de manière optimale les dimensions de l'élément bas. Le miroir Light souligne les proportions et la verticalité de l'espace, accentuée par le spot à led Plano fixé sur le miroir.

Strenge Formen und entschlossene Linie zeichnen diese Zwilling-Kombinationen in Nussbaum Antico Scuro und lackiert in Bianco Velvet aus. Das vorgeschlagene Waschbecken ist Kuki, dessen 50 cm breites Becken die Abmessungen des Unterschrankes optimal nutzt. Der Spiegel Light unterstreicht die Proportionen und die senkrechten Linien des Raums, die durch die am Spiegel befestigte LED-Leuchte Plano betont werden.

Строгость и решительность линий характеризуют эти парные композиции в отделке Орех Antico Scuro и лакированный bianco velvet. Раковина Kuki с чашей 50 см оптимально использует размеры тумбы. Зеркало Light подчеркивает пропорции и вертикальность пространства и акцентируется светодиодным светильником Plano, закрепленным на зеркале.

**dimensioni** L 60.6 × P 50.5 cm

**finiture** 7A1 NOCE ANTICO SCURO /  
905V0 LACCATO BIANCO VELVET

**lavabi** Kuki in Fenix Bianco Kos sp.1.2 x L 60.6  
× P 50.5 cm + scivolo

**specchiera** Light L 60 x H 120 cm

**faretto** Plano led

## MATERIA VIP composizione 08

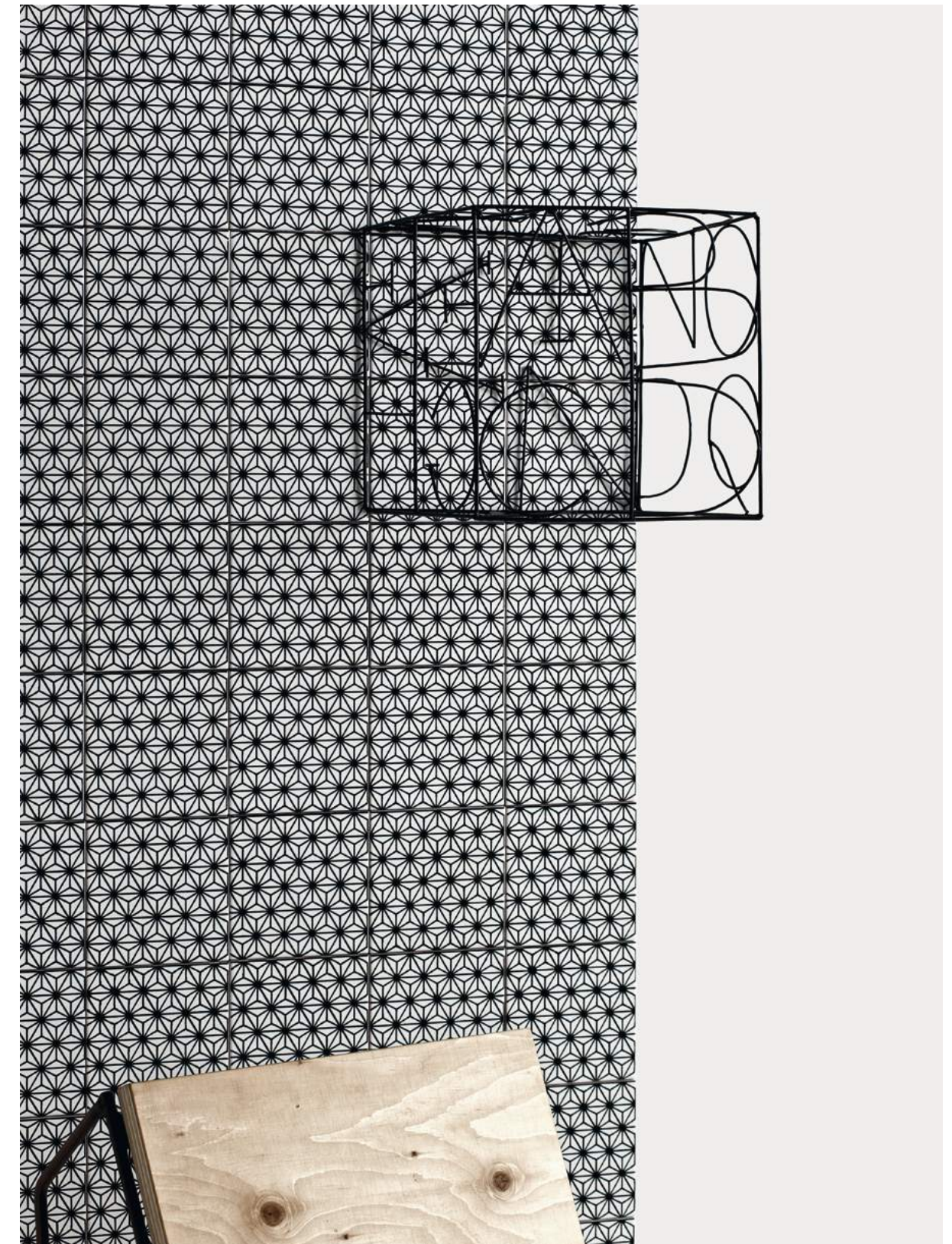



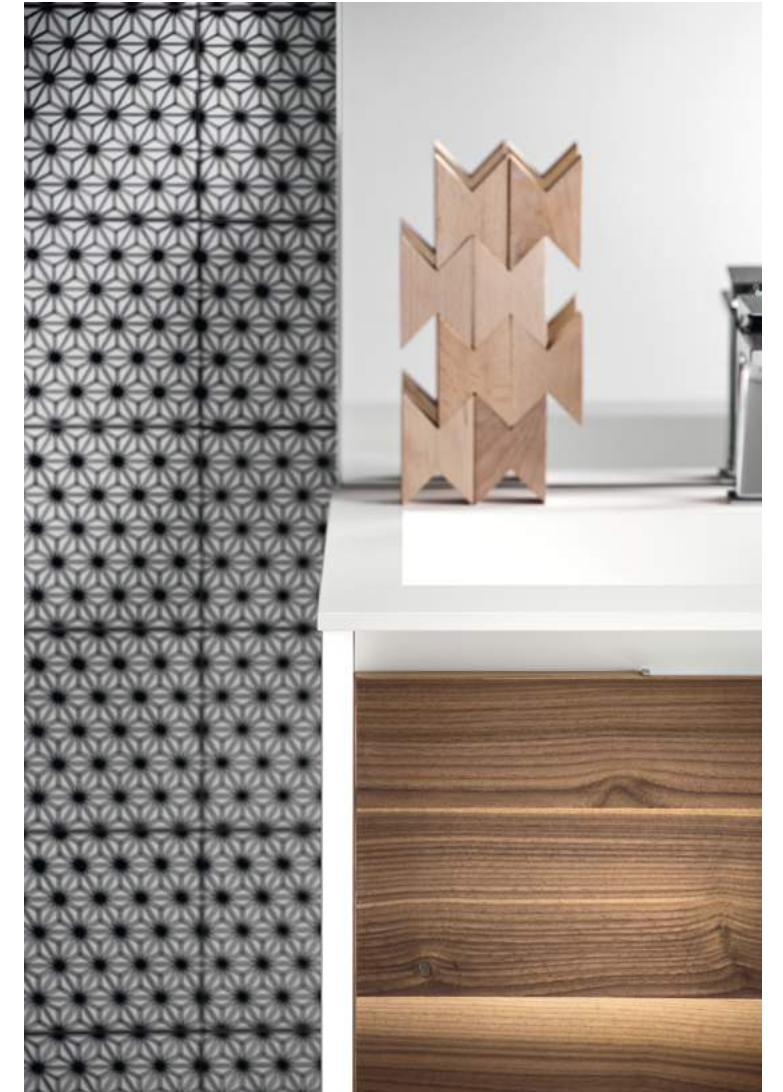















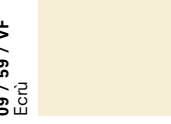
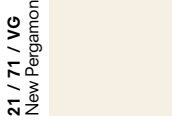





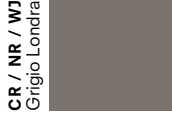







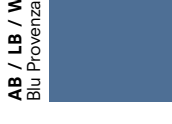

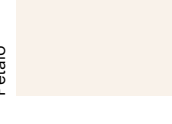





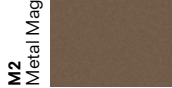
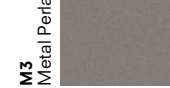

<b>AU / LU / V1</b> Polline		<b>30 / 80 / V2</b> Giallo Solare		<b>C2 / N2 / V4</b> Rosso Lacca		<b>31 / 81 / V5</b> Rosso Fuoco		<b>48 / 98 / V6</b> Lampone		<b>37 / 87 / V8</b> Rosso Rubino	
<b>CN / NN / WF</b> Rosso Casale		<b>CO / NO / WG</b> Cachi		<b>CP / NP / WH</b> Sahara		<b>AH / LH / VO</b> Safari		<b>CB / NB / VV</b> Bisonite		<b>CA / NA / VU</b> Terra	
<b>18 / 68 / VW</b> Cacao		<b>27 / 77 / VX</b> Carruba		<b>C3 / N3 / VD</b> Burro		<b>09 / 59 / VF</b> Ecrù		<b>21 / 71 / VG</b> New Pergamon		<b>AG / LG / VN</b> Corda	
<b>C0 / N0 / VE</b> Juta		<b>C9 / N9 / VS</b> Stone		<b>CG / NQ / WI</b> Castoro Ottawa		<b>AN / LN / VP</b> Creta		<b>CR / NR / WJ</b> Grigio Londra		<b>C7 / N7 / VQ</b> Cub	
<b>C1 / N1 / VY</b> Tè Verde		<b>CS / NS / WK</b> Fiordo		<b>AD / LD / VB</b> Turchese		<b>AV / LV / VZ</b> Petrolio		<b>CC / NC / W0</b> Grigio Baltico		<b>CT / NT / WL</b> V. Comodoro	
<b>CD / ND / W2</b> Mercurio		<b>02 / 52 / W6</b> Ceruleo		<b>CE / NE / W3</b> Blu Lapponia		<b>CU / NU / WM</b> Bluriva		<b>AB / LB / W5</b> Blu Provenza		<b>AM / LM / VL</b> Glicine	
<b>C5 / N5 / V1</b> Blush		<b>C4 / N4 / VH</b> Petalò		<b>900A0 / 901L0</b> 905V0 Bianco		<b>CF / NF / W7</b> Sambuco		<b>CV / NV / WN</b> Grigio Efeso		<b>AZ / LZ / W8</b> Ghiaccio	
<b>19 / 69 / W9</b> Gri. Manhattan		<b>AQ / LQ / WA</b> Genere		<b>CG / NG / WB</b> Grigio Rabbit		<b>CW / NW / W0</b> Grigio Bromo		<b>AX / LX / WC</b> Fumo di Londra		<b>26 / 76 / WD</b> Nero	
<b>M1</b> Metal Pinot								<b>M2</b> Metal Magnum			
										<b>M3</b> Metal Perlage	

**MATERIA laccato**  
opaco, lucido\*, velvet e metal

\* lucido solo per frontale





**MATERIA (frontali)**  
**rovere legno**



**MATERIA (frontali)**  
**noce antico\*** \* solo per Materia Vip e Dry

**MATERIA (frontali)**  
**rovere antico\*** \* solo per Materia Vip e Dry

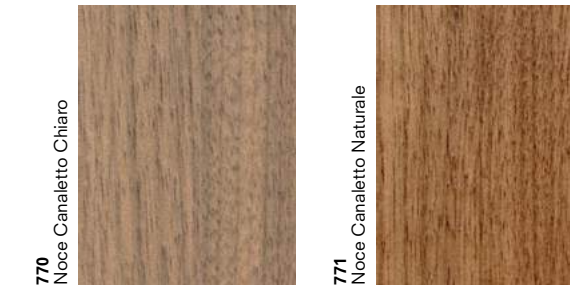

**MATERIA (frontali)**  
**noce canaletto\*** \* solo per Materia Way

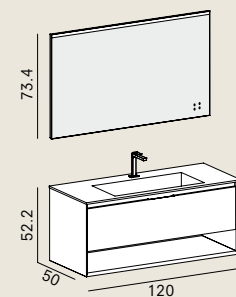
Arbi, 2019  
p — 59Materia Vip  
size compositions

**Materia Vip 01** L 120.6 cm × P 50.0 cm  
p — 04 905V0 bianco velvet  
/ 8A2 rovere antico crema

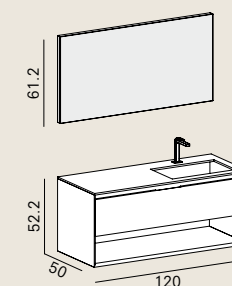

**Materia Vip 05** L 120.6 × P 50.5 cm  
p — 08 WF rosso casale velvet

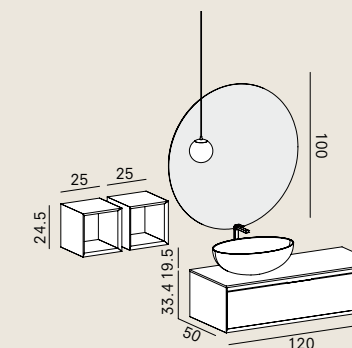

**Materia Vip 02** L 120.6 × P 50.5 cm  
p — 16 (L 140 cm con sporg. specchio)  
WJ grigio Londra velvet  
/ 8AA rovere antico inchiostro

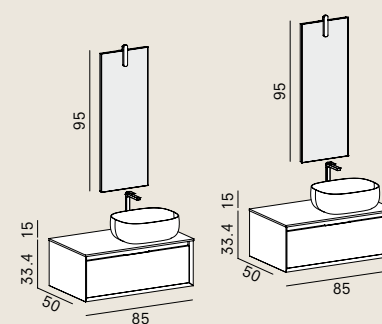

**Materia Vip 03** L 85.6 × P 50.5 cm  
p — 22 WL verde comodoro velvet  
/ 901L0 bianco lucido

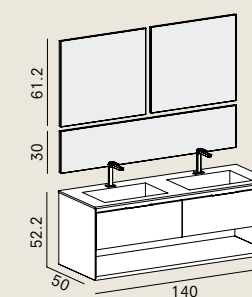

**Materia Vip 04** L 140.6 × P 50.5 cm  
p — 28 WN grigio efeso velvet  
/ 8A9 rovere antico masai

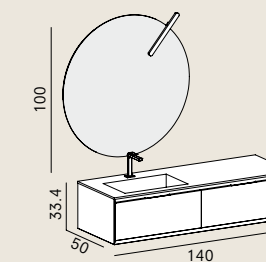

**Materia Vip 06** L 140.6 × P 50.5 cm  
p — 34 (L 155 cm con sporg. specchio)  
905V0 bianco velvet  
/ 7A2 noce antico biondo

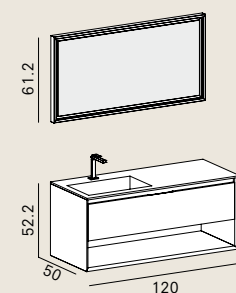

**Materia Vip 07** L 120.6 × P 50.5 cm  
p — 42 WO grigio bromo velvet  
/ 8A8 rovere antico essenza

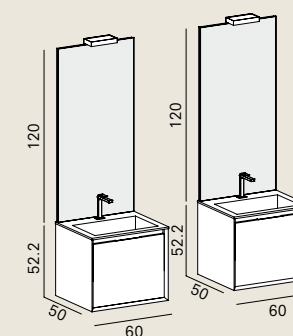

**Materia Vip 08** L 60.6 × P 50.5 cm  
p — 48 905V0 bianco velvet  
/ 7A1 noce antico scuro

**MATERIA VIP**  
size compositions.

# ARBI

BATHROOM

## ARBI ARREDOBAGNO SRL

viale Lino Zanussi, 34/A  
33070, Maron di Brugnera  
Pordenone / Italy

+39 0434 624822  
info@arbiarredobagno.it  
www.arbiarredobagno.it

## CREDITS

**design**  
Ufficio Tecnico Arbi

**graphic design**  
Ufficio Tecnico Arbi

**styling**  
Daniela Moioli  
Francesco Simoni  
Sara Sarli

**photo**  
Contratti Company  
Fotografica / Riccardo Munarin

**color separation**  
Lucegroup.it

**thanks to**  
Delamont  
Lush (Udine)  
Valobra

**print**  
AGCM (PN)  
September, 2018

